

## STEEL DRUM 15L

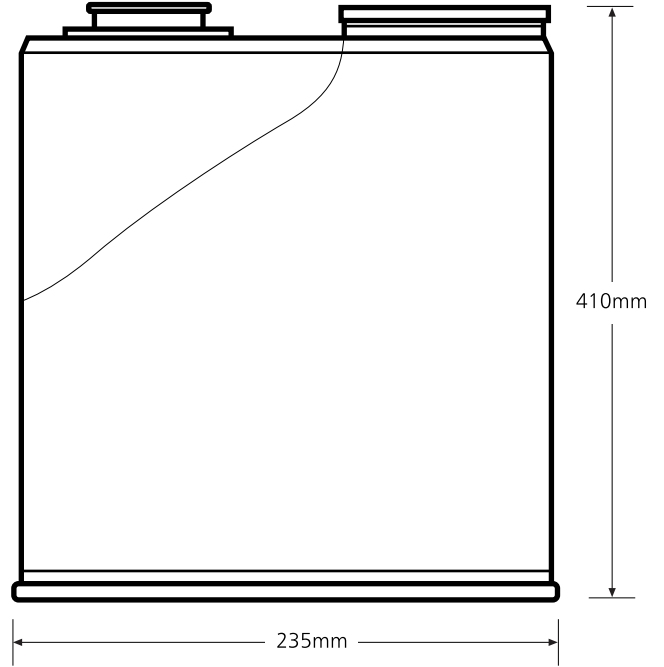

### Container

Size	Closure	Weight	Drop Height	Steel Dims (Body)	UN Approval	No. Pallet
15L	G2 & G <sup>3</sup> / <sub>4</sub> Tri-Sure steel Closures	2.2kg	1.8m	0.6mm	1A1/X/400/**/GB/5322	100

### Applications:

Chemical, Paint, and Petroleum and Food Industries.

### Nexus Packaging Ltd.

7 Centurion Business Park, Shields Road, Glasgow, G41 1HH

Tel: 0141 429 2525 | Fax: 0141 429 2060 | Email: admin@nexpack.co.uk

REGISTERED IN SCOTLAND: No. SC262044 | VAT No. 829 6449 83